

LT WHOLESALE

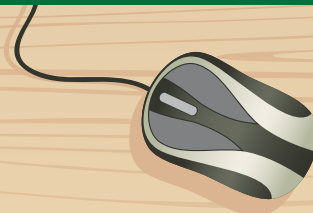

LT WHOLESALE
2010 CATALOG
FOLDERS • CALENDARS • PLANNERS • PADFOLIOS

Sunday	Monday	Tuesday	Wednesday	Thursday	Friday	Saturday
JUN 2010					1 121 244 169	2 122 243
3 123 242	4 124 241 168	5 125 240 167	6 126 239 165	7 127 238 164	8 128 237 163	9 129 236
10 130 235	11 131 234 162	12 132 233 161	13 133 232 160	14 134 231 159	15 135 230 158	16 136
17 137 228	18 138 227 157	19 139 226 156	20 140 225 155	21 141 224 154	22 142 223 153	23 143
24 144 221	25 145 220 152	26 146 219 151	27 147 218 150	28 148 217 149	29 149 216 148	30 150
31 151 215	Days elapsed in 2010 = 264 = Days remaining in 2010 = 137					152
Days remaining in 2010, excluding weekends and New Year's Day, Memorial Day, Independence Day, Labor Day, Thanksgiving, and Christmas						
SMTWTFS 1 2 3 4 5 6 7 8 9 10 11 12 13 14 15 16 17 18 19 20 21 22 23 24 25 26 27 28 29 30 31	SMTWTFS 1 2 3 4 5 6 7 8 9 10 11 12 13 14 15 16 17 18 19 20 21 22 23 24 25 26 27 28 29 30 31	SMTWTFS 1 2 3 4 5 6 7 8 9 10 11 12 13 14 15 16 17 18 19 20 21 22 23 24 25 26 27 28 29 30 31	SMTWTFS 1 2 3 4 5 6 7 8 9 10 11 12 13 14 15 16 17 18 19 20 21 22 23 24 25 26 27 28 29 30 31	SMTWTFS 1 2 3 4 5 6 7 8 9 10 11 12 13 14 15 16 17 18 19 20 21 22 23 24 25 26 27 28 29 30 31	SMTWTFS 1 2 3 4 5 6 7 8 9 10 11 12 13 14 15 16 17 18 19 20 21 22 23 24 25 26 27 28 29 30 31	SMTWTFS 1 2 3 4 5 6 7 8 9 10 11 12 13 14 15 16 17 18 19 20 21 22 23 24 25 26 27 28 29 30 31

2010
LT WHOLESALE

LT Wholesalers is a wholesaler of the highest quality customized printed items. We have an array of fully customized folders for any business need. From real estate, medical, finance to logistics, our customizable business folders can be used for any industry.

Our selection of calendars range from wall, desk, easel and planner books and are unbeatable marketing tools for any type of business or industry. Every calendar we create can be customized to suit the needs of any customer.

LT Wholesalers has found a niche in the market place and we have surpassed the competition in quality and pricing.

Our Mission is to deliver the highest level of professionalism and creative solutions that will enable our customers to keep an edge over the competition.



If you don't see exactly what you're looking for within the pages of this catalog, please call us and we can create it together!

We make YOUR business OUR business!

Folders

- Presentation Folder 4
- Homeowners Folder Mini..... 5
- Homeowners Folder 6
- Escrow Information Folder..... 7
- Escrow Document Folder 8
- Listing / Sale Folder..... 9
- Refi Escrow Folder 10

Calendars

- Easel Calendars 12
- Wall Calendars 12
- Customized Desktop Calendars 13-14

Weekly Planners

- Pocket Planners 16
- Customized Weekly Planners..... 17
- Customized Weekly Planner Inserts..... 18

Padfolios

- Padfolios..... 19-20

Pricing

- Pricing and Art Specs 21-22

FOLDERS



Eliminate the Chaos!
Use the Right Tools for the Job!

Presentation Folder

Item #: LT-05PF2

Make a great first time impression! Presentation folders are a unique and classy way of protecting your important documents while giving them respect! Leave a lasting impression on your clients.

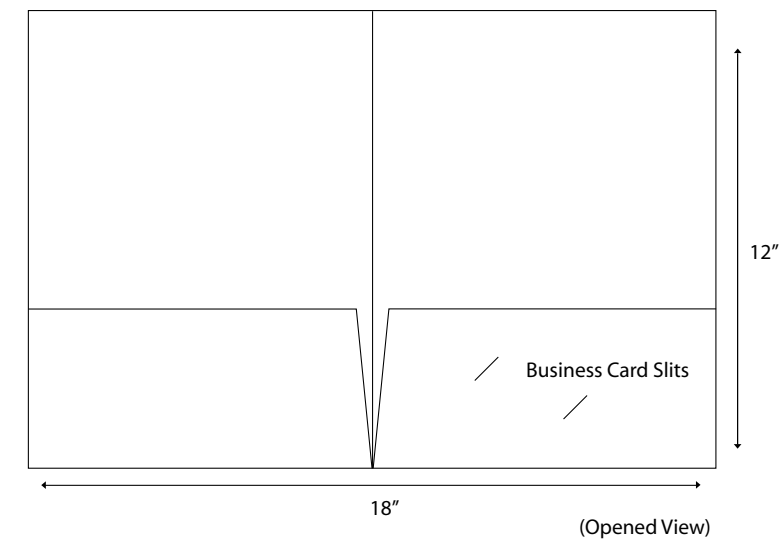
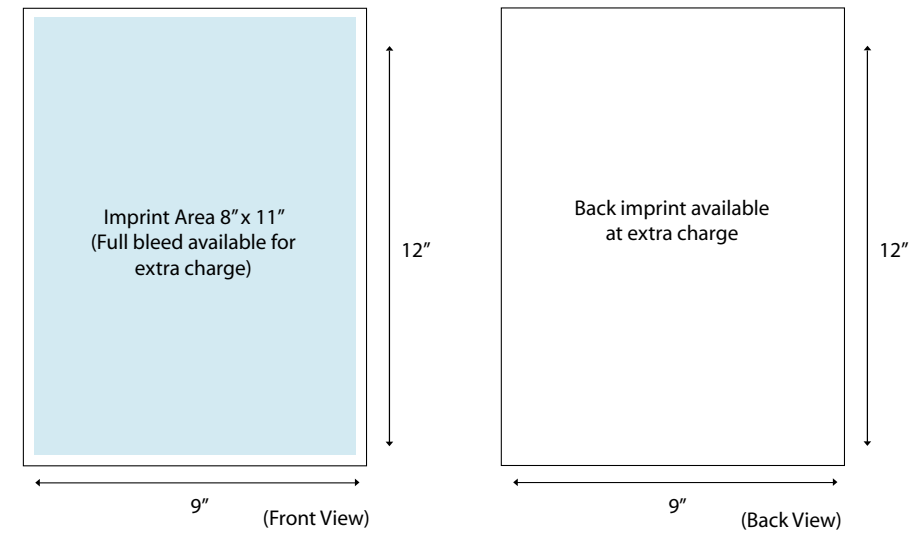

Features:

- Two 4" Glued Pockets
- Business Card Slits
- Can Accommodate Vertical or Horizontal Business Cards

Size: 9" x 12"

Paper Stock: 110 Lb.

Ink Color: 1 – 2 Color(s)

Foil Stamping or Full Color Available at an Additional Cost, Please Call for Pricing

GET ORGANIZED AND PROMOTE YOUR BUSINESS IN STYLE!

See Pricing on Page 20

Homeowners Folder (Available in 2" and 4" expansion)

Item #: LT-08HOD2 & LT-08HOD4

Our Homeowner Document Folder will truly set your customers apart from competitors. Available with a 2" or 4" expansion, the quality of this product allows new home buyers to safely secure all of the important documents that they will want to keep for many years. This item leaves a lasting impression on clients, and keeps the company image in front of the customer.

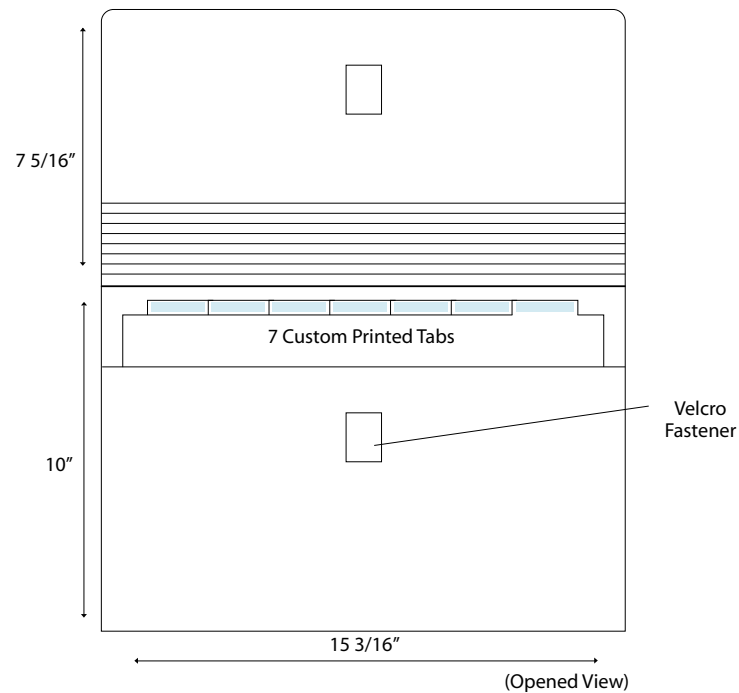
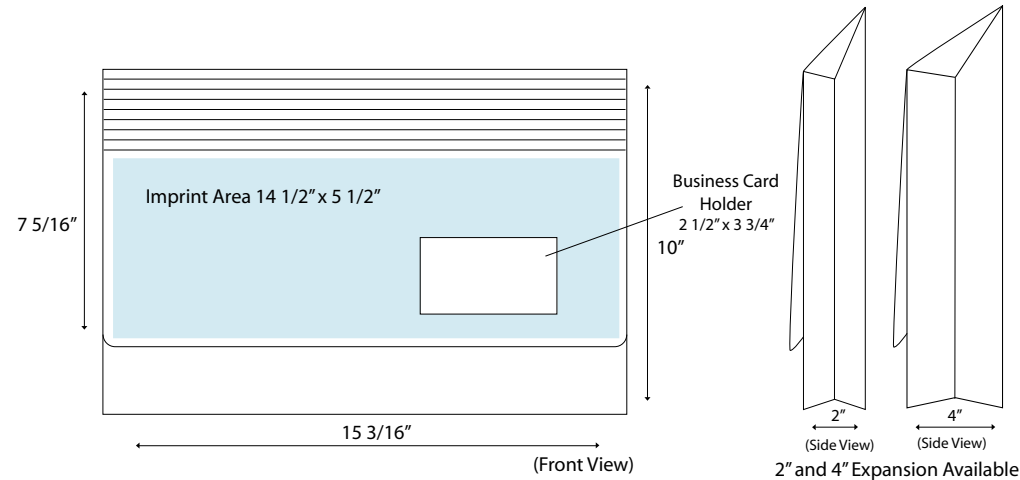

Features:

- Vinyl Business Card Holder
- Tabbed Inserts
- Fold Over Flap with Velcro Enclosure
- 2" or 4" Expandable Gussets
- Heavy Laminate Finish

Standard Tabbed Inserts: Title & Escrow / Contracts & Disclosures / Inspections & Reports / Mortgage Records / Homeowners Insurance / Property Tax / Other

*Custom Tabbed Inserts Available at an Additional Cost; Please Call for Pricing

Size: 10" x 15 3/16"

Paper Stock: 130 Lb. C1S Cardboard with Laminate Finish

Ink Color: 1 – 2 Color(s)

Inserts: 7 Inserts with Tabs (Available with Gloss Lamination; Call for Pricing)

Homeowners Folder Mini

Item #: LT-08HODM

The same great quality as our Homeowner Document Folders, without an expansion.

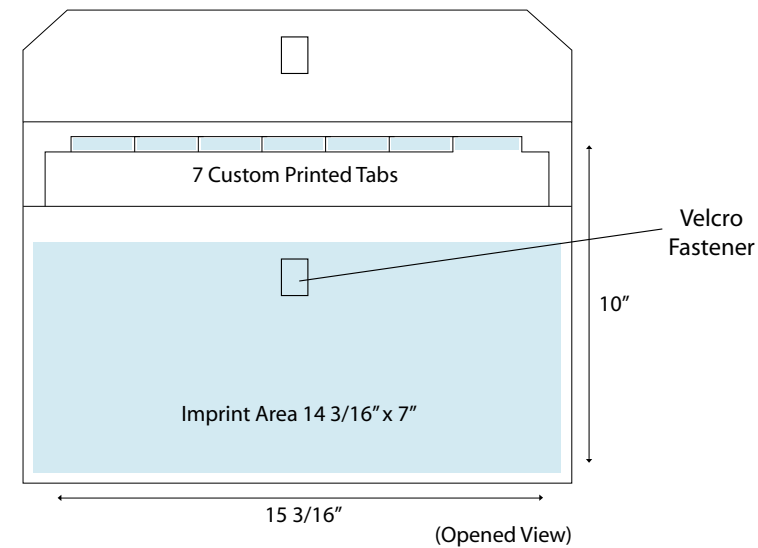
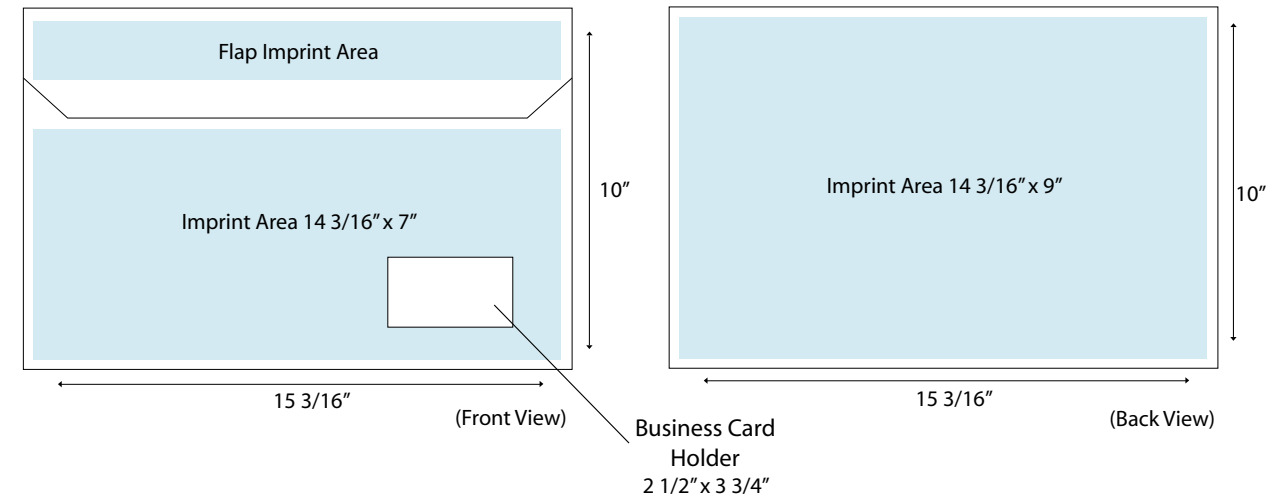

Features:

- Vinyl Business Card Holder
- Tabbed Inserts
- Fold Over Flap with Velcro Enclosure

Standard Tabbed Inserts: Title & Escrow / Contracts & Disclosures / Inspections & Reports / Mortgage Records / Homeowners Insurance / Property Tax / Other

*Custom Tabbed Inserts Available at an Additional Cost; Please Call for Pricing

Size: 15 3/16" x 10"

Paper Stock: 80 Lb. Cover Uncoated Paper

Ink Color: 1 – 2 Color(s)

Inserts: 7 Inserts with Tabs (Available with Gloss Lamination; Call for Pricing)

Escrow Information Folder

Item #: LT-0922

Impress your clients with this highly functional, great looking and multi use jacket folder. This product keeps important documents safe, secure, and organized. Keep your company name in front of clients at all times during each transaction!

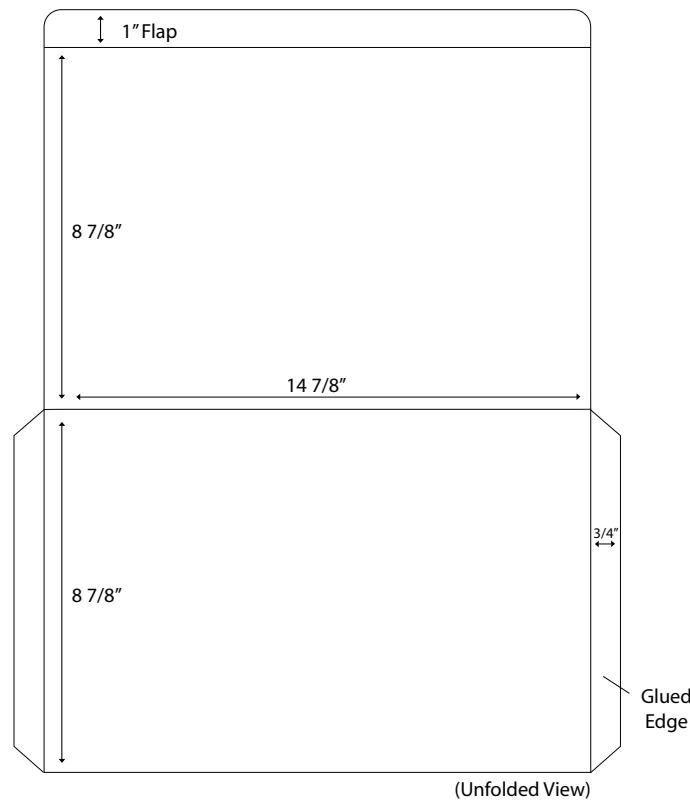
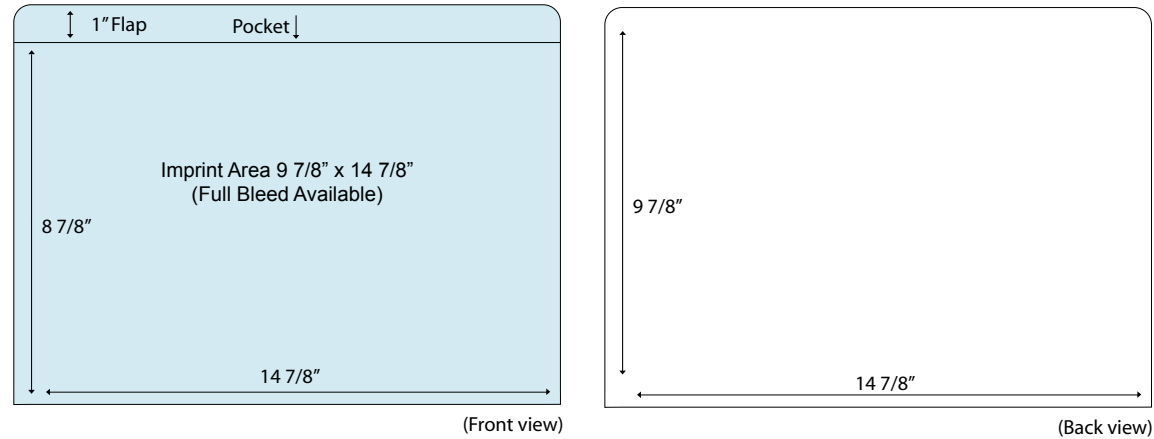

Features:

- Front, Back, Tab Printing
- Round or Square Corners

Size: 15 1/2" x 10 1/2" (finished)

Paper Stock: 100 Lb. Text Uncoated Paper

Ink Color: 1 – 2 Color(s)



See Pricing on Page 20

Escrow Document Folder

Item #: LT-0923

This heavy-duty and fully customized jacket folder has a glossy finish and 2" expansion which allows for safe storage of important documents. Real Estate agents will find this product accommodating for all of their transaction needs.

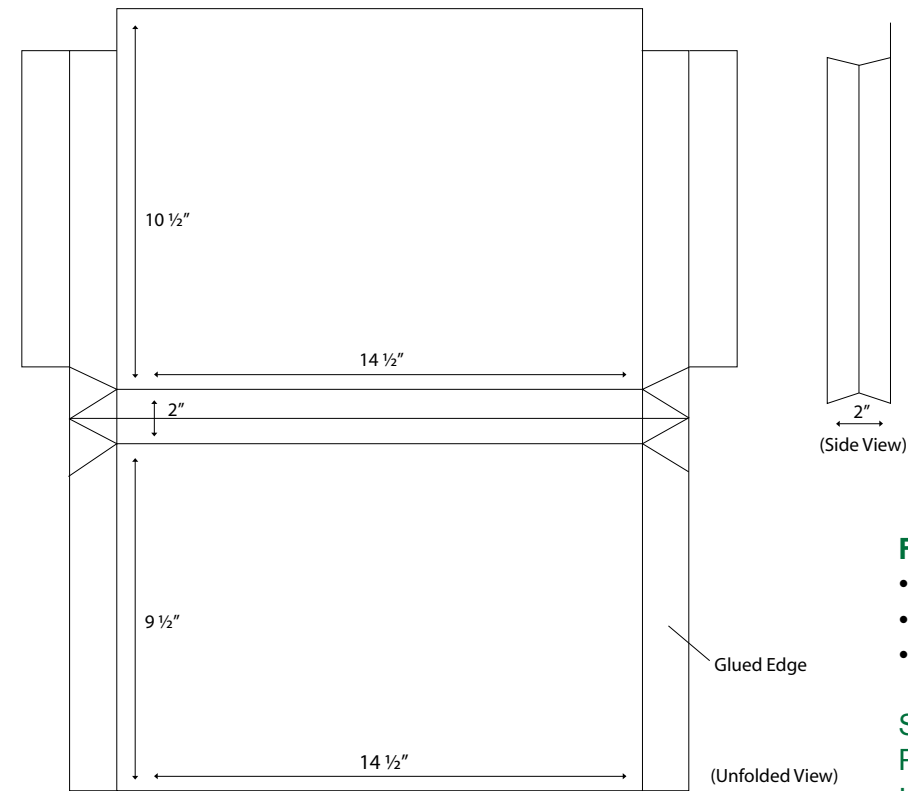
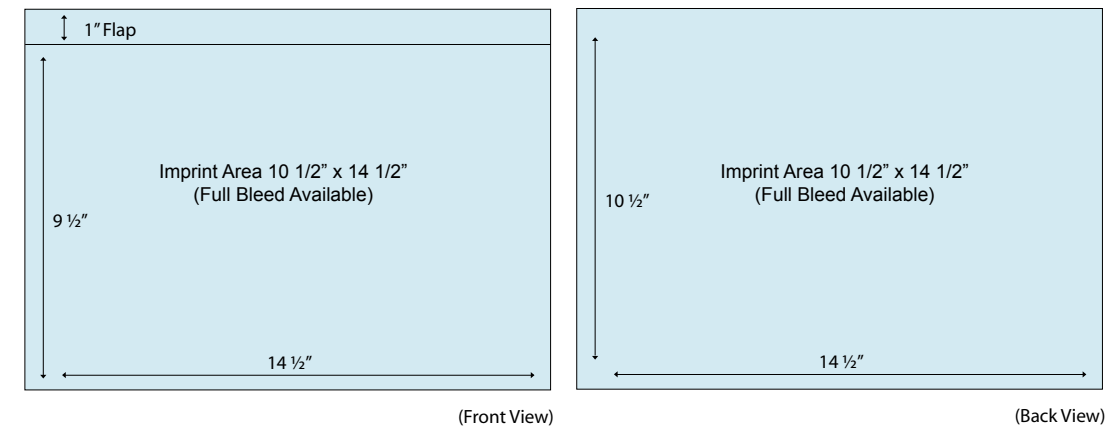

Features:

- Front, Back, Tab Printing
- Square Corners
- 2" Expansion

Size: 15" x 10" x 2"

Paper Stock: 130 Lb. C1S Cardboard

Ink Color: 1 – 2 Color(s)

See Pricing on Page 20

Listing/Sale Folder

Item #: LT-0962

Your escrow and mortgage customers will find these folders extremely useful for each transaction. This folder includes five colored page inserts designed to be used with two hole bracket fasteners. A great way to show your customers you're working for them! This folder and the inserts are highly functional for a variety of uses. Keep track of property information, listing & selling offices and buyer and seller information. This legal size folder packs a lot of functionality for your customers while providing you with a great marketing tool!

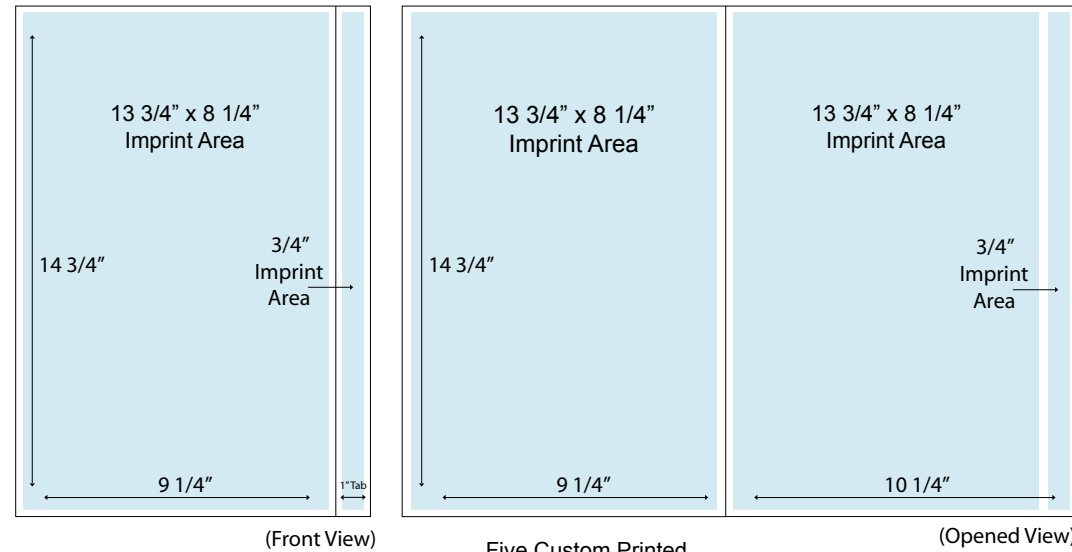

(Front View)

(Opened View)

Five Custom Printed
14 1/2" x 9" Tabs Included

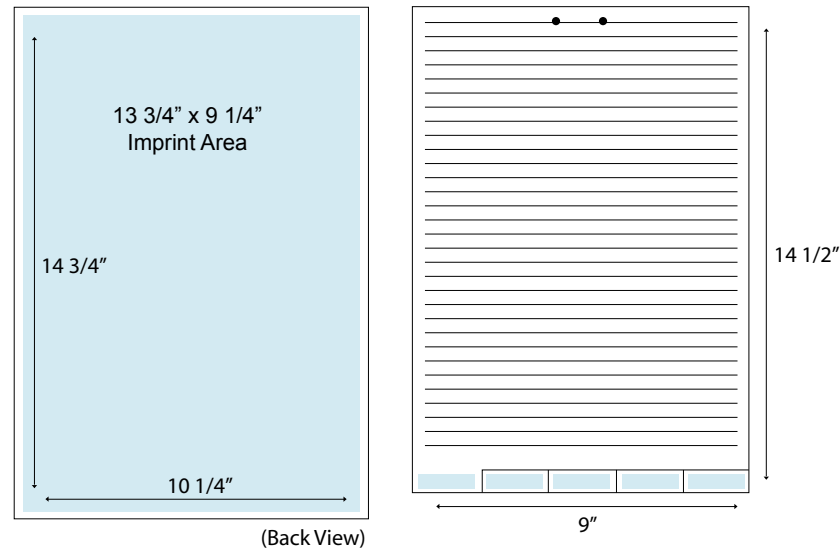

(Back View)

Features:

- Front, Back Internal Printing
- Tabbed Inserts

Standard Tabbed Inserts: Purchase Agreements / Inspections & Disclosures / Escrow, Title, Insurance & Loan / Notes & Miscellaneous and Listing Agreement.

*Custom Tabbed Inserts Available at an Additional Cost; Please Call for Pricing

Size: 15 1/4" x 10 1/2" (finished)

Paper Stock: 100 Lb. Text Uncoated Paper

Ink Color: 1 – 2 Color(s)

Inserts: 5 Inserts with Tabs

STANDARD
CONVERSATIONAL
LOG AVAILABLE!

See Pricing on Page 20

Refi Escrow Folder

Item #: LT-06REF

This folder is great for organizing client information, individual projects, and other transaction details. Equipped with the capabilities of printing front, back and inside, this item is perfect for a conversation log and other tracking processes.

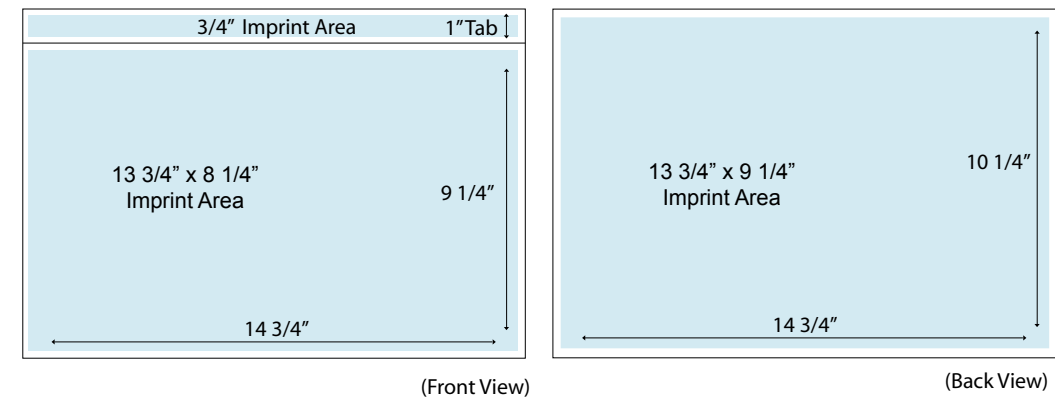

(Front View)

(Back View)

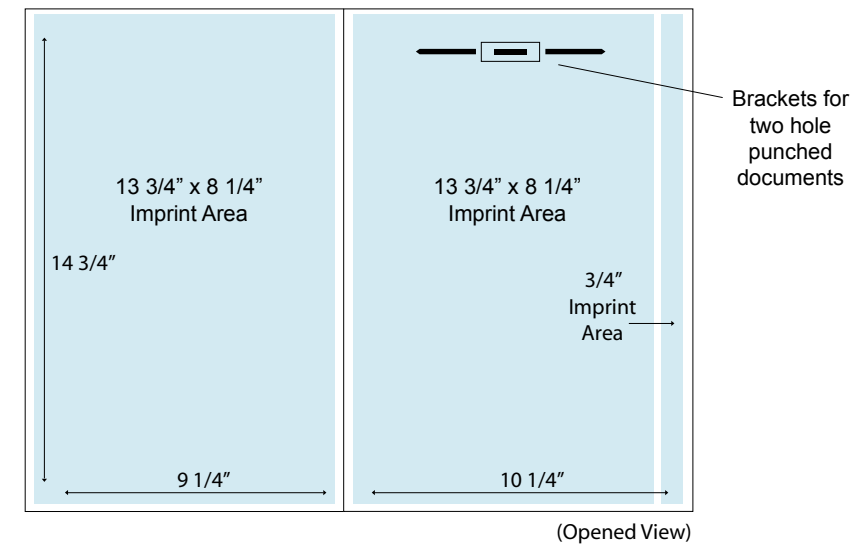

(Opened View)

STANDARD
CONVERSATIONAL
LOG AVAILABLE!

Features:

- Front, Back, Internal Printing
- Internal Fastener

Folded Size: 14 3/4" x 10 1/4"

Paper Stock: 130 Lb. C1S Cardboard

Ink Color: 1 Color

Refi Escrow Folder

LT-0944

This folder boasts the same features as our 'LT-06REF Reference Folder' but **without the fastener**. This particular folder can be used for various functions within any business place.

SAME GREAT LOOK &
FUNCTIONALITY!

Features:

- Front, Back, Internal Printing

Folded Size: 14 3/4" x 10 1/4" (finished)

Paper Stock: 130 Lb. C1S Cardboard

Ink Color: 1 Color

See Pricing on Page 21

CALENDARS



Keep Your Company Name in Front of Your Customers
12 Months... 52 Weeks... 365 Days

Easel Calendar

Item #: DT-4C

Easel pad calendar with turn over pages takes up little space on a desk top and is a great way to advertise. Each page can send a different message to your customer. Easel pad is a vinyl wrap over 0.5mm chip board.

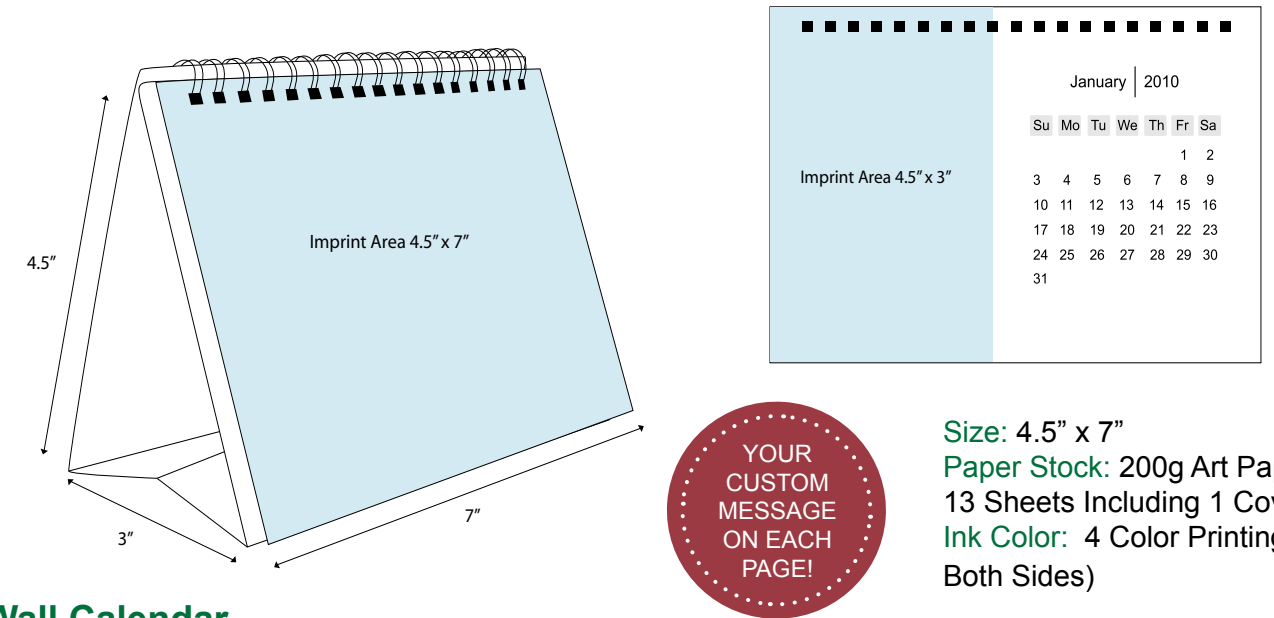

Wall Calendar

Item #: Wall 10-10

Our wall calendars are available in four unique sizes. Each calendar is unique. Stock artwork is available or customer can submit their own artwork. A full color watermark imprint on the calendar grid is included in the price!

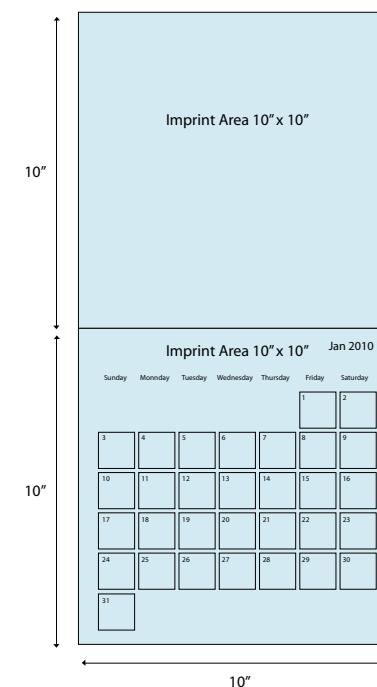

Features:

- Glossy Lamination on Cover
- Saddle Stitch Binding

Size: 10" x 20" (Folded 10" x 10") *
Paper Stock: 128 Gsm C2S Art Paper (Inside)
250 Gsm C2S Art Paper (Cover)
Ink Color: CMYK Printing Throughout

*Additional Sizes Available:

9.8" x 9.8"
11" x 11"
13.8" x 13.8"

See Pricing on Page 21

Completely Customized Desktop Calendars

Three different styles to help you create the perfect marketing tool.

Item # DPC 3C1

Three color standard calendar grid! This calendar makes the perfect splash with added color. One location imprint area. Price includes one color.

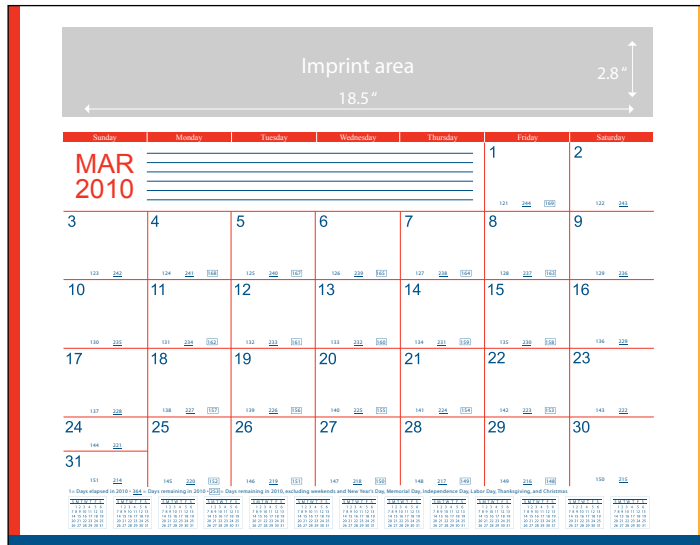

Item #: DPC 1C1A

Calendar grid available in blue or black. One location imprint area. Price includes one color.

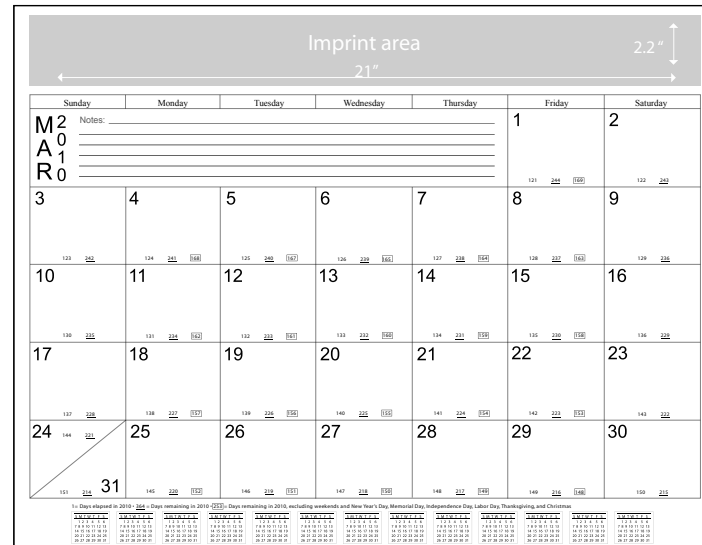

Item #: DPC 1C2A

Calendar grid available in black or blue. Two imprint areas - add extra value by giving your customer extra room for added company information. Price includes one color.

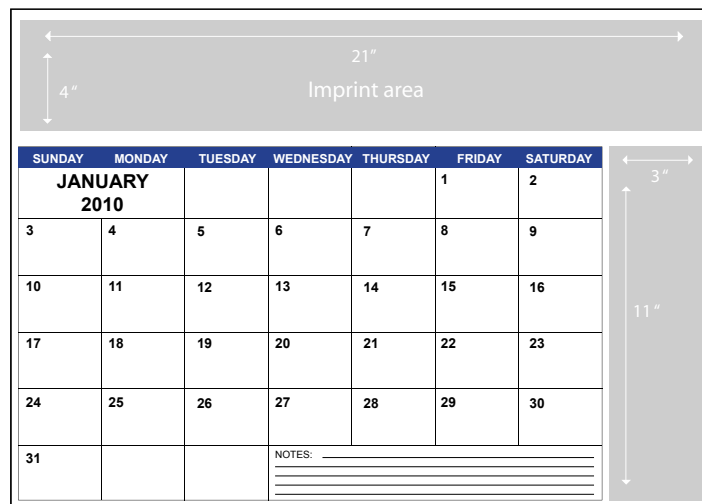

Features:

- 12 Page Calendar
- Full Year at a Glance at Bottom with Current Month Highlighted
- Days Elapsed, Days Remaining and Days Remaining Excluding Weekend and Certain Holidays Available upon Request on any Style
- Choice of 6 Leatherette Corner Colors - Reinforced Corners (Black, Blue, Burgundy, Green, Red, or Clear Plastic)
- Additional Colors and Pages Available. See Pricing.
- Watermark on Calendar Grid Available. See Pricing.



See Pricing on Page 22

Completely Customized Desktop Calendars

Customized calendar examples.

Item # DPC 3C1

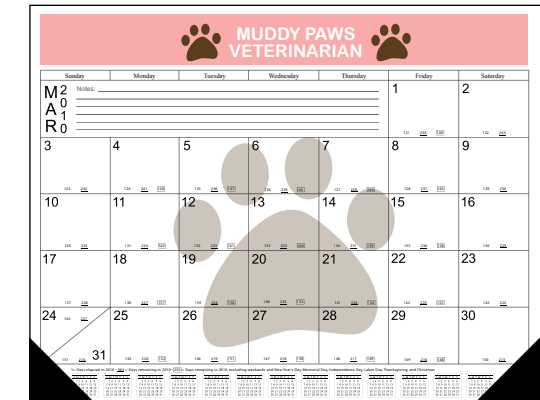
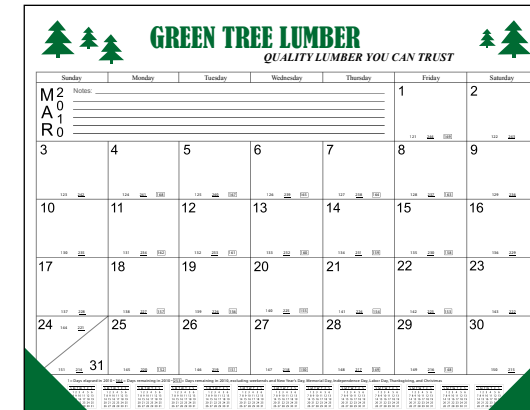

Item # DPC 1C1A

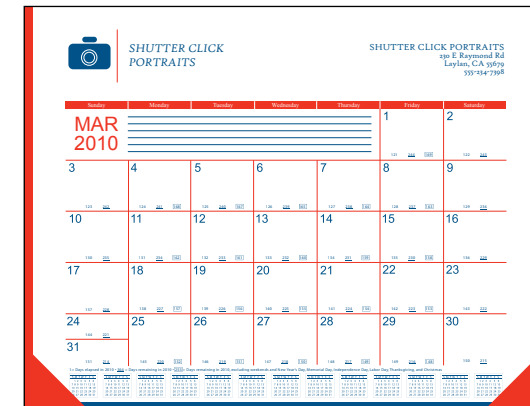

Item # DPC 1C2A

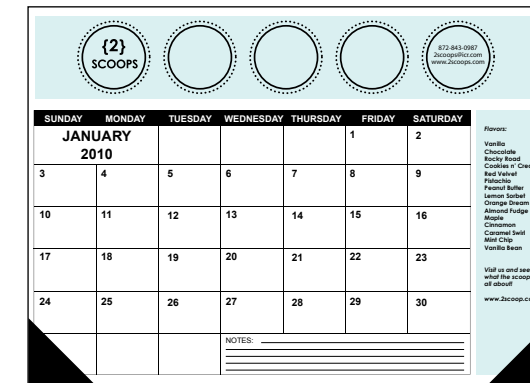

Corner Colors



See Pricing on Page 22

PLANNERS



A Tool for any Industry on the Go!
12 Months... 52 Weeks... 365 Days

Pocket Planners

Item #: PP

An economical way to keep your company name in front of your customers all year long. These handy pocket planners are designed to fit in purses, pockets, or any small space. Month at a Glance, Personal Info and Name/Address Pages. Price includes choice of cover color.

6"

7"

3 1/2"

PERSONAL INFORMATION

Name _____
Address _____
City _____ State _____ Zip _____
Phone # _____
E-mail _____

Business Name _____
Address _____
City _____ State _____ Zip _____
Phone # _____
E-mail _____

Auto Insurance Policy # _____
License Plate # _____
Driver's License # _____

MEDICAL INFORMATION

Blood Type _____ Allergies _____
Physician _____
Phone # _____
Health Insurance Policy _____

IN CASE OF EMERGENCY NO.

Name _____
Home Phone # _____
Work Phone # _____

FLOWERS

January • Carnation
February • Violet
March • Jonquil
April • Sweet Pea
May • Lily of the Valley
June • Rose
July • Larkspur
August • Gladiolus
September • Aster
October • Calendula
November • Chrysanthemum
December • Narcissus

"Nearly all men can stand adversity,
but if you want to test a man's character,
give him power."
Abraham Lincoln

JANUARY

1	2	3	4	5		
6	7	8	9	10	11	12
13	14	15	16	17	18	19
20	21	22	23	24	25	26
27	28	29	30	31		

SUN MON TUE WED THU FRI

NOTES

3	4	5	6	7	8	1
			Ash Wednesday	14	15	16
10	11	12	13	14	15	16
		Lincoln's Birthday		21	22	23
17	18	19	20	21	22	23
	President's Day			28	29	
24	25	26	27	28	29	

2011

1 Square 1 Realty

my 2008

2" x 6" Pockets on Inside Cover For Easy Insertion.

Leatherette Cover Colors



See Pricing on Page 23

Planners

Completely Customized Weekly Planners

Completely customized Week at a Glance. Includes full custom insert page at front of book (two sided.) Leatherette cover, hidden spiral binding. Gold or silver embossing on the cover with gold or silver corner tabs on the front.

Item #: WP7

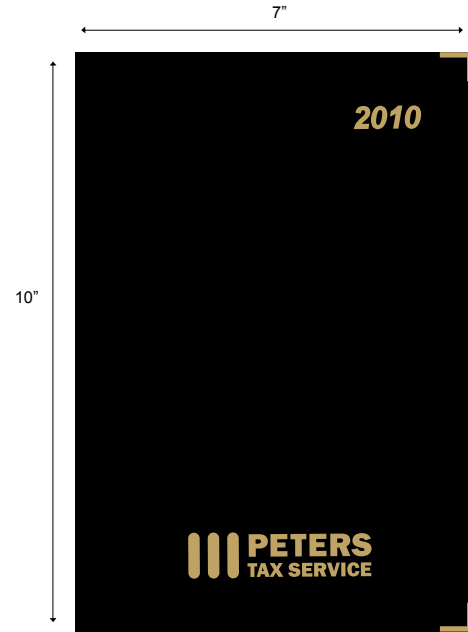

Item #: WP8

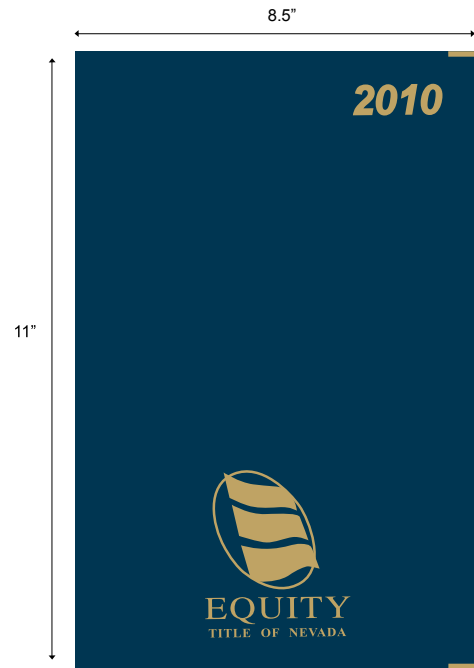

Leatherette Cover Colors

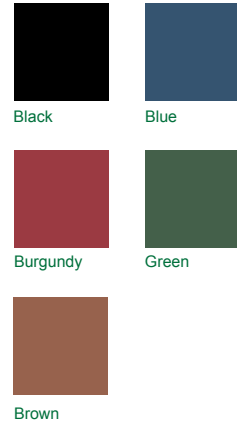

THE PERFECT GIFT FOR IMPORTANT CLIENTS AND EMPLOYEES!

Two Layouts to Choose From!

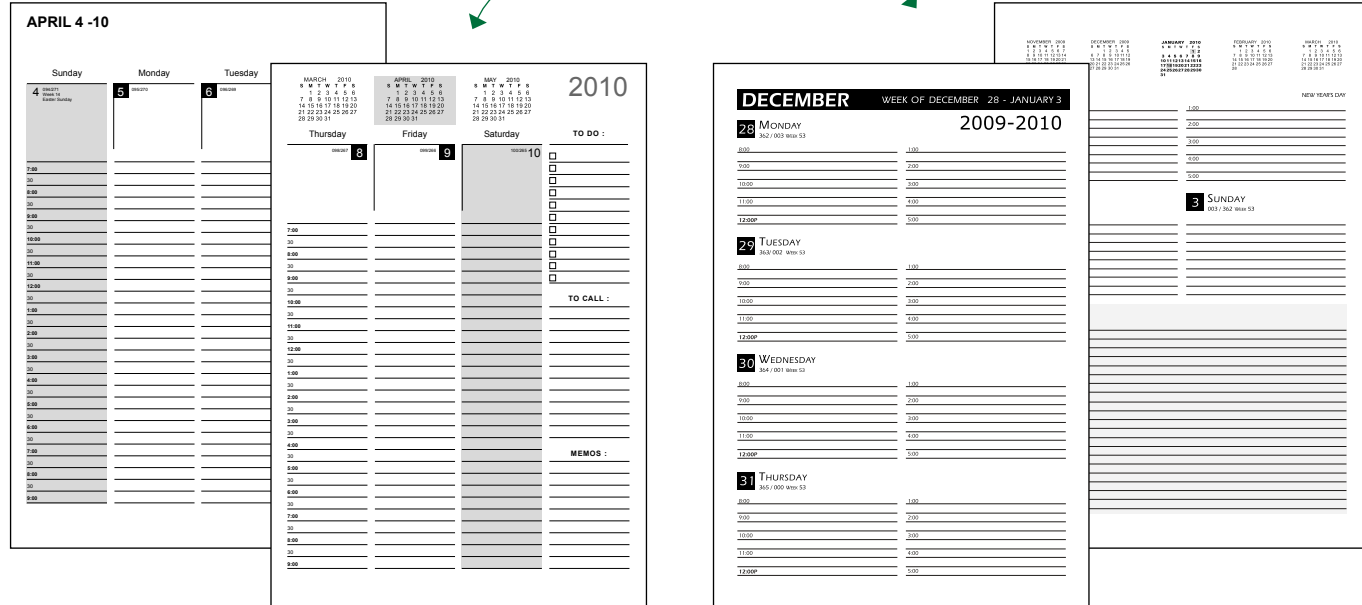

See Pricing and Special Options Available on Page 23

Completely Customized Planner Insert Pages

Personalize your weekly planner with choice of two layouts for inside pages. Add a custom insert page to make your planners unique!

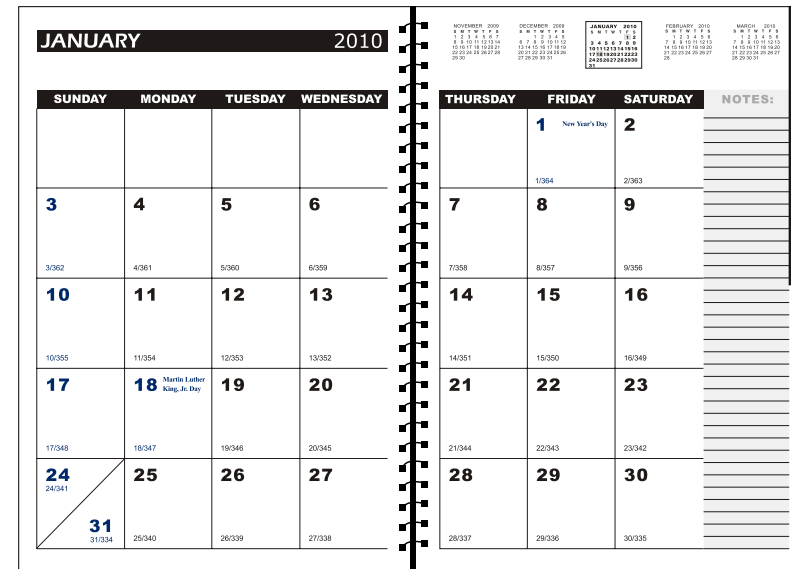

* Refer to Pricing for Additional Information

Two Month at a Glance Layouts to Choose From!

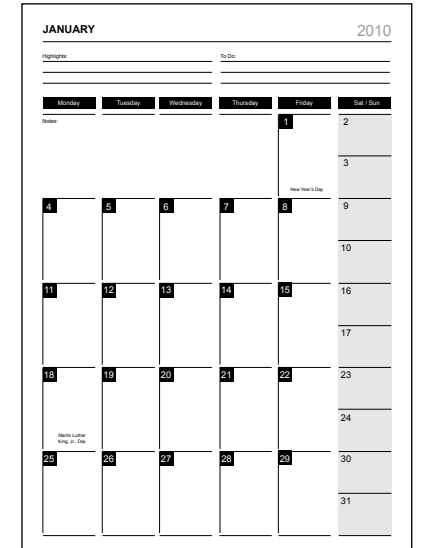

Back



(Sample) Optional Custom Insert Page. Two Sided. Up to 4 Colors Available.*

See Pricing on Page 23

*Art Supplied by Customer.

PADFOLIOS

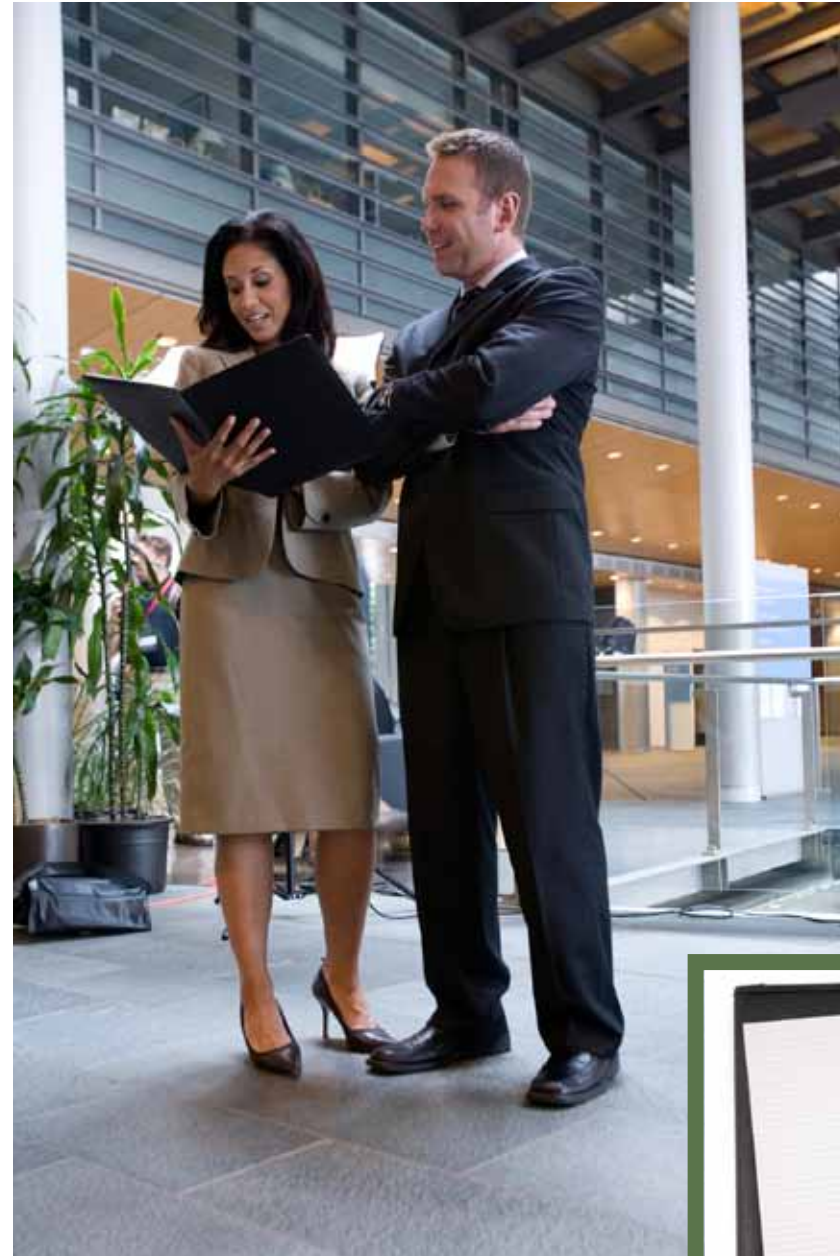

The Right Tool for any Business Professional!
Combining Professional Image With Functionality

Padfolio

Item #: LT75 Pad

Highly functional for the business person on the go. Two popular sizes and three options to choose from. Each padfolio comes with a calculator and a writing pad. Each style is available with a zipper or flap and snap enclosure. Durable leatherette material gives the look and feel of real leather.



Features:

- PVC Material for Both Inside and Outside
- Outside Logo Emboss
- Memo Pad: With Logo Printing
- Pen Loop, Cell Phone Pocket
- Calculator

Size: 9.8" x 13.5"

Padfolio

Item #: LT75 Delux



Features:

- PVC Material for Both Inside and Outside
- Outside Logo Emboss
- Memo Pad: With Logo Printing
- Calculator

Size: 9.8" x 13.5"

Padfolio

Item #: LT75 Mini



Features:

- PU Material for Both Inside and Outside
- Outside Logo Emboss
- Binder

Size: 7.48" x 10"

FABULOUS GIFT IDEA!
SAY 'THANK YOU' 'JOB WELL DONE' OR 'HAPPY HOLIDAYS'

Pricing and Art Specs

Presentation Folder

LT-05PF2

QTY	500	1,000	2,000	3,000	5,000	7,500	10,000
PRICE	\$4.14	\$2.57	\$1.71	\$1.35	\$1.11	\$0.98	\$0.86 ^(A)

Homeowners Folder

LT-08H0D2 (2 inch expansion)

QTY	500	1,000	2,000	3,000	5,000	7,500	10,000
PRICE	\$11.54	\$5.17	\$4.60	\$3.92	\$3.49	\$3.12	\$2.94 ^(A)

LT-08H0D4 (4 inch expansion)

QTY	500	1,000	2,000	3,000	5,000	7,500	10,000
PRICE	\$14.94	\$9.09	\$7.23	\$6.34	\$5.00	\$4.40	\$4.09 ^(A)

Homeowners Folder Mini

LT-08H0DM

QTY	500	1,000	2,000	3,000	5,000	7,500	10,000
PRICE	\$9.97	\$5.74	\$3.69	\$3.15	\$2.66	\$2.50	\$2.66 ^(A)

Escrow Information Folder

LT-0922

QTY	500	1,000	2,000	3,000	5,000	7,500	10,000
PRICE	\$3.97	\$2.43	\$1.63	\$1.30	\$0.97	\$0.78	\$0.60 ^(A)

Escrow Document Folder

LT-0923

QTY	500	1,000	2,000	3,000	5,000	7,500	10,000
PRICE	\$5.34	\$2.77	\$1.86	\$1.63	\$1.38	\$1.25	\$1.03 ^(A)

Listing Sale Folder

LT-0962

QTY	500	1,000	2,000	3,000	5,000	7,500	10,000
PRICE	\$8.00	\$5.60	\$4.16	\$3.64	\$3.11	\$2.90	\$2.67 ^(A)

Refi Escrow Folder

LT-06REF

QTY	500	1,000	2,000	3,000	5,000	7,500	10,000
PRICE	\$4.74	\$2.60	\$1.89	\$1.64	\$1.43	\$1.24	\$1.20 ^(A)

LT-0944

QTY	500	1,000	2,000	3,000	5,000	7,500	10,000
PRICE	\$3.89	\$2.17	\$1.57	\$1.21	\$0.97	\$0.87	\$0.80 ^(A)

Easel Calendars

DT-4C (Price includes your custom message on each page)

QTY	1,000	3,000	5,000	7,000	10,000	15,000
PRICE	\$3.86	\$2.22	\$1.83	\$1.74	\$1.54	\$1.44 ^(A)

Wall Calendars

Wall 10-10

QTY	1,000	3,000	5,000	7,000	10,000	15,000
PRICE	\$5.49	\$2.53	\$2.00	\$1.80	\$1.54	\$1.41 ^(A)

Desktop Calendars

DPC 3C1 - Up to 2 Colors

QTY	500	1,000	2,000	4,000	6,000	10,000	20,000
PRICE	\$11.27	\$7.13	\$5.30	\$4.08	\$3.71	\$3.37	\$3.22 ^(A)

*Add \$0.19 per calendar for additional month/page
*Add \$0.19 per calendar for watermark logo on each page

DPC 3C1 - 3-4 Colors

QTY	500	1,000	2,000	4,000	6,000	10,000	20,000
PRICE	\$11.40	\$7.26	\$5.43	\$4.21	\$3.84	\$3.50	\$3.35 ^(A)

*Add \$0.19 per calendar for additional month/page

DPC 1C1A & DPC 1C2A - 1 Color

QTY	500	1,000	2,000	4,000	6,000	10,000	20,000
PRICE	\$6.85	\$4.50	\$3.14	\$2.61	\$2.41	\$2.29	\$2.18 ^(A)

*Add \$0.19 per calendar for additional color
*Add \$0.19 per calendar for additional month/page
*Add \$0.19 per calendar for watermark logo on each page

DPC 1C1A & DPC 1C2A - Full Color

QTY	500	1,000	2,000	4,000	6,000	10,000	20,000
PRICE	\$8.45	\$5.35	\$3.98	\$3.06	\$2.78	\$2.53	\$2.41 ^(A)

*Add \$0.19 per calendar for additional month/page

Pocket Planners

PP

QTY	500	1,000	3,000	5,000	7,000	10,000	15,000
PRICE	\$4.40	\$2.46	\$1.29	\$0.74	\$0.63	\$0.55	\$0.47 ^(A)

Weekly Planners

WP7 (7" x 10")

QTY	500	1,000	2,000	3,000	5,000	7,500	10,000
PRICE	\$11.29	\$8.92	\$6.79	\$5.49	\$4.69	\$4.43	\$4.28 ^(A)

Add \$0.25 Per Book for Watermark on Every Other Page

WP8 (8.5" x 11")

QTY	500	1,000	2,000	3,000	5,000	7,500	10,000
PRICE	\$11.49	\$9.12	\$6.99	\$5.69	\$4.89	\$4.63	\$4.48 ^(A)

Add \$0.25 Per Book for Watermark on Every Other Page

*Add \$1.50 Per Book for a Full View of Month at a Glance (Spread Over Two Pages)
See Sample on Page 18

Padfolios

LT75 Pad

QTY	500	1,000	2,000	3,000	5,000	7,500	10,000
PRICE	\$25.51	\$17.23	\$16.14	\$14.96	\$14.03	\$13.37	\$12.09 ^(A)

LT75 Delux

QTY	500	1,000	2,000	3,000	5,000	7,500	10,000
PRICE	\$27.71	\$20.09	\$18.17	\$16.33	\$15.69	\$14.80	\$14.14 ^(A)

LT75 Mini

QTY	500	1,000	2,000	3,000	5,000	7,000	10,000
PRICE	\$21.14	\$13.54	\$12.00	\$11.20	\$10.66	\$9.92	\$9.39 ^(A)

Art Specs

Artwork requirements:

Vector based art is the preferred format for all artwork. Please create outlines for all images and fonts.

Art Formats Accepted:

AI, EPS, PDF, PS, CDR, ID, JPEG (If 300 DPI)

Min. DPI requirement:

300

Art Software:

Adobe Illustrator, Adobe InDesign, Adobe Photoshop, Adobe Dreamweaver, Adobe PageMaker.

Art Department Assistance:

Our in-house art department is available at the rate of \$65.00/hour for any work needed in updating or recreating your existing art files. Artwork may be sent electronically to: artwork@ltwholesalers.com

DIDN'T FIND WHAT YOU
WERE LOOKING FOR?

CALL US AND WE CAN CREATE IT TOGETHER!

SAGE #: 68447 PPAI #: 408744
UPIC: LTWHLSLE

FOLDERS

PRESENTATION FOLDERS • HOMEOWNERS FOLDERS • ESCROW

CALENDARS

EASEL • WALL • DESKTOP

PLANNERS

POCKET PLANNERS • WEEKLY PLANNERS • MONTH AT A GLANCE

PADFOLIOS

ORGANIZATIONAL TOOLS

We are happy to help you make the most out of your promotional products.

Sage #: 68447 • PPAI #: 408744 • UPIC: LTWHLSLE